

Schalldruckpegel L_A (dB) = Schall-Leistungspegel L_W (aus Diagramm) minus 19 dB

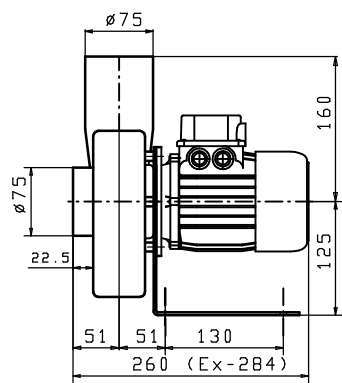

Ständerausführung ML

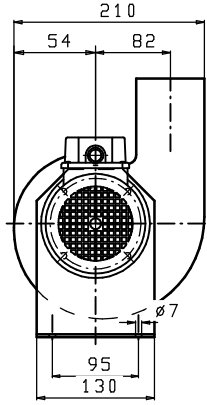
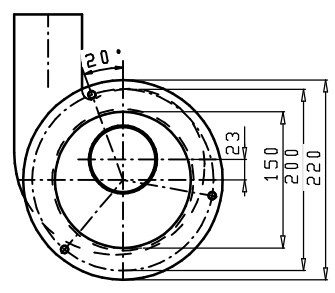
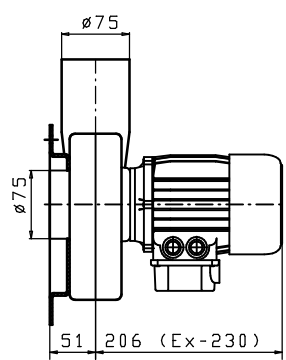

Flanschausführung MLF

Mögliche Gehäusestellungen

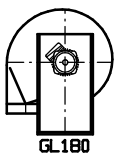
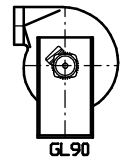
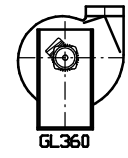

Maßänderungen vorbehalten